



2



AMORTIGUADOR PARA PUERTA

AMORTIGUADOR PARA CORREDERA

AMORTIGUADOR PARA BISAGRA

AMORTIGUADOR PARA GUÍA CAJÓN

TOPE AMORTIGUADOR ADHESIVO

TOPE AMORTIGUADOR EMBUTIR

AMORTIGUADORES Y TOPES

TACO AMORTIGUADOR



CÓDIGO

7253286

ACABADO

Niquelado



200

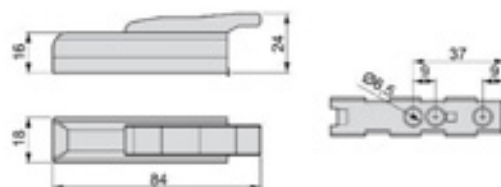

TACO PORTASMOVE



CÓDIGO

GR9266210

MODELO

Con tope

ACABADO

Niquelado



150

GR9266510

Sin tope

Niquelado

150

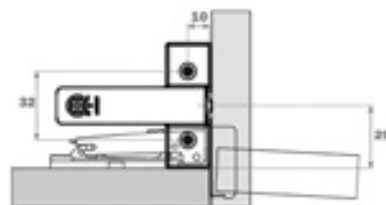

TACO AMORTIGUADOR ZITTO



CÓDIGO

7255188

ACABADO

Gris



100

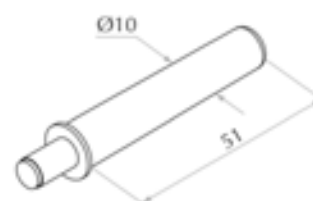

SOPORTE SUPERFICIE ZITTO



CÓDIGO

7255686

MODELO

Horizontal

ACABADO

Gris



100

7255786

S32

Gris

100

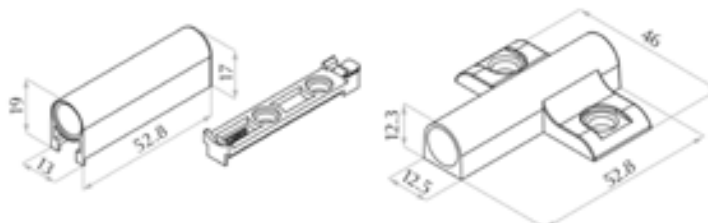

AMORTIGUADOR INDA UNIVERSAL

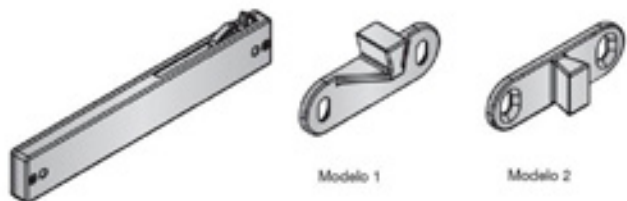

CÓDIGO	MODELO	ACABADO	20
4770101	1	Gris	20
4770202	2	Gris	20

*Cada juego se compone de 1 amortiguador y 1 activador mod. 1 o mod. 2.

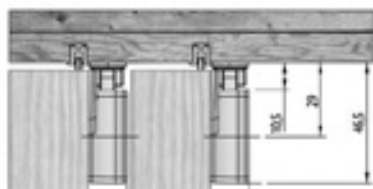
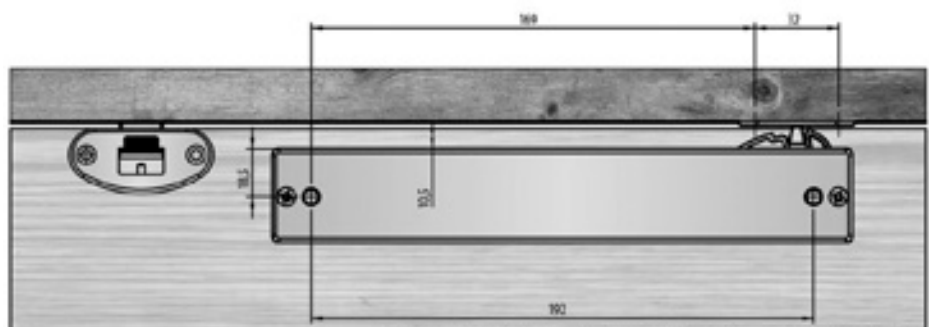
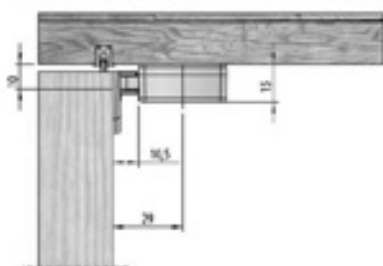
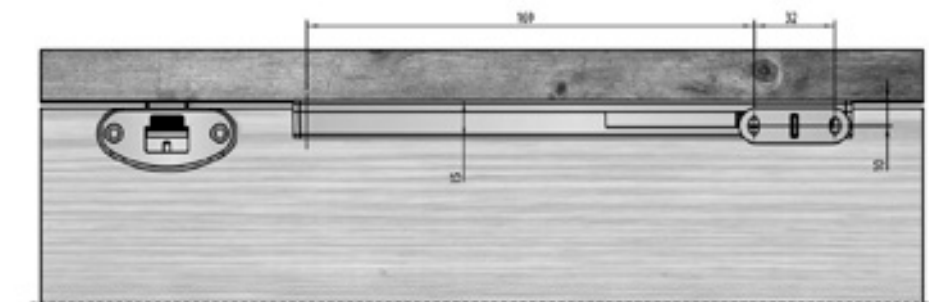
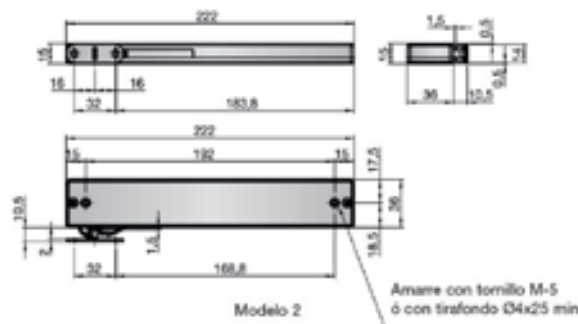
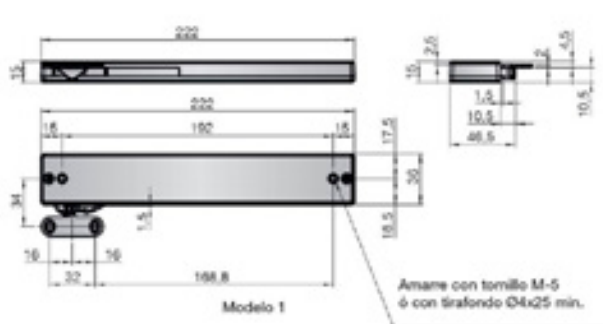

AMORTIGUADORES Y TOPES

AMORTIGUADOR I-48 INDA ESTÁNDAR



CÓDIGO	ACABADO	
180903060	Niquelado	125

AMORTIGUADOR BISAGRA FGV ALFA



CÓDIGO	ACABADO	
521590620	Niquelado	125

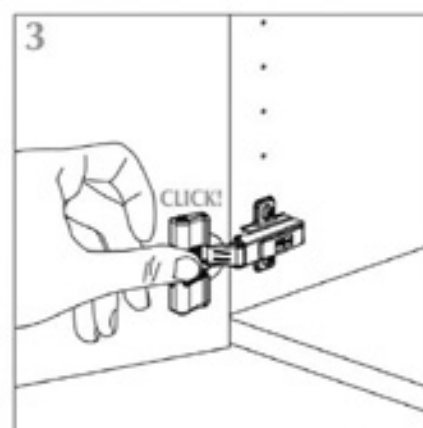
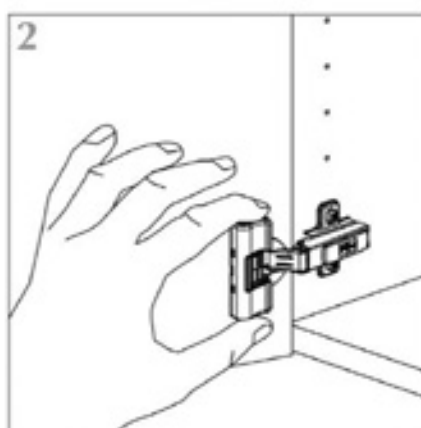
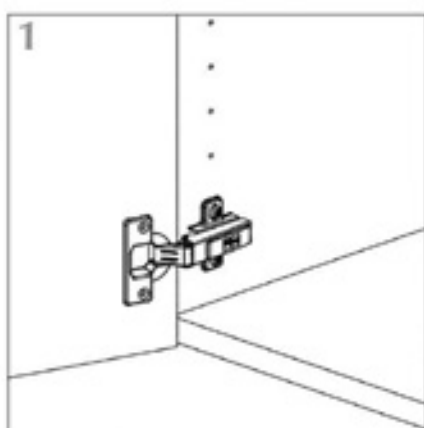

AMORTIGUADOR + TOPE INDAMATIC



CÓDIGO	MODELO GUÍA	ACABADO	
4720289	Bolas 17 mm. Cisne	Gris	50
4720087	Corredera Gacela	Gris	50

CISNE

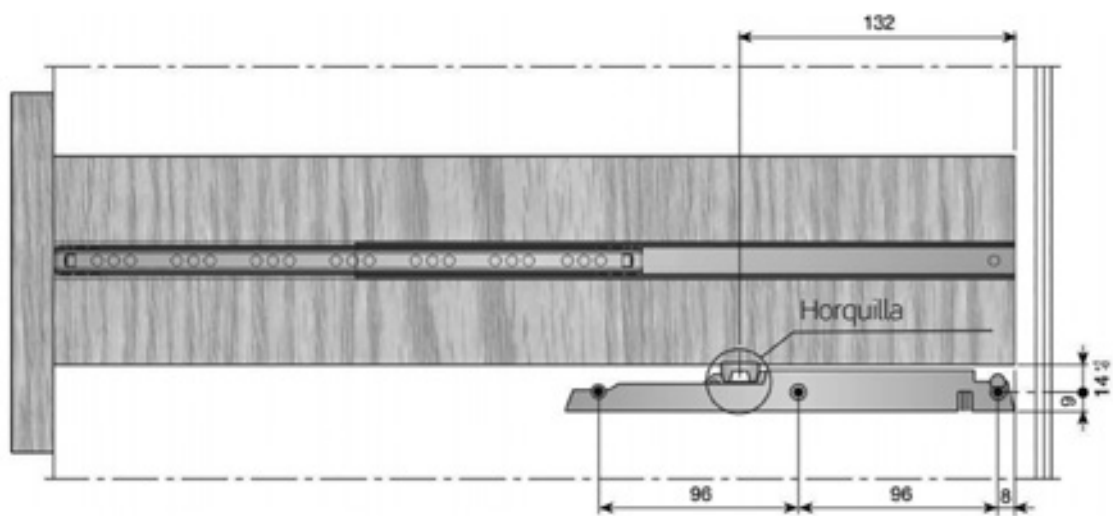

GACELA

Fijación en el costado

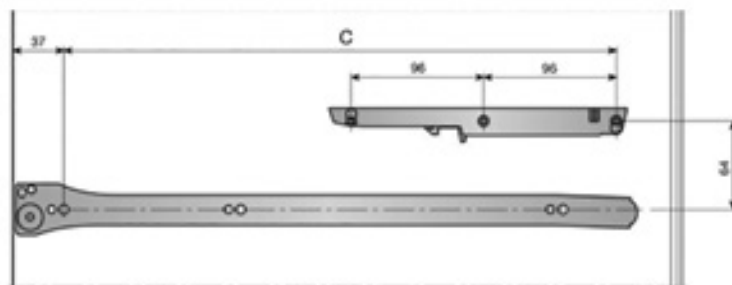

Long. cajón	B	C
250	108	192
300	140	224
350	204	288
400	268	352
450	300	384
500	364	448
550	396	480
600	460	544
700	556	640
800	652	736

Fijación en el cajón

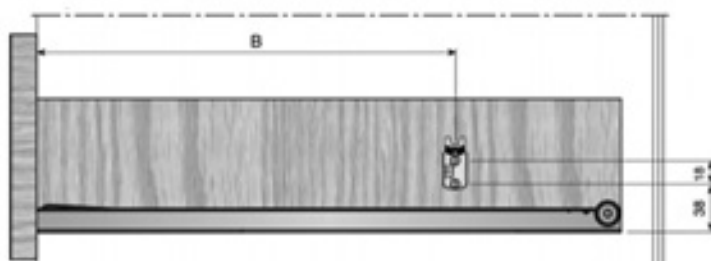

AMORTIGUADORES Y TOPES

TACO AMORTIGUADOR SOFT GOMA D.5

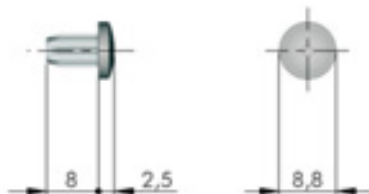

CÓDIGO	ACABADO	
7211450	Transparente	5.000

TACO AMORTIGUADOR FLEX

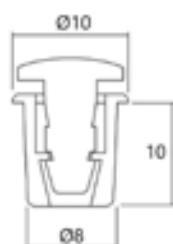

CÓDIGO	ACABADO	
7211387	Gris	5.000

TACO AMORTIGUADOR EU GOMA D.8

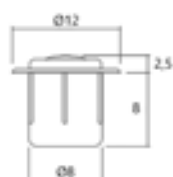

CÓDIGO	ACABADO	
7211786	Gris	1.000

TACO AMORTIGUADOR D.5 ESTRIADO

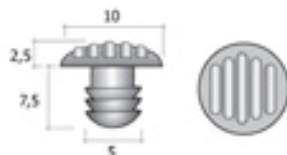

CÓDIGO	ACABADO	
7211651	Blanco	5.000
7211652	Marrón	5.000
7211653	Negro	5.000

TACO 1 PUNTA AMORTIGUADOR

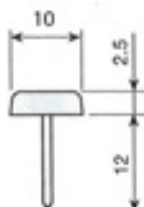

CÓDIGO	ACABADO	
7212051	Blanco	5.000
7212054	Roble	5.000
7212086	Gris	5.000

TACO LÁGRIMA ADHESIVO

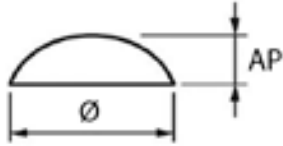

CÓDIGO	Ø	AP	ACABADO	
7213050	7	1,5	Transparente	10.000
7213350	8	2,2	Transparente	8.000
7213150	10	1,5	Transparente	10.000
7213250	10	3	Transparente	5.000
7213450	13	4	Transparente	4.000
7213853	15	8	Negro	1.000
7213950	16	1	Transparente	1.600

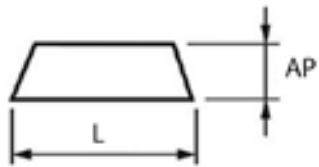

TACO ADHESIVO CUADRADO

CÓDIGO	L	AP	ACABADO	
7213750	12,5	5,8	Transparente	4.000



Los topes adhesivos se pueden suministrar en varios formatos y cortados a medida.